

RACCORDI DA MANDRINARE

RICAVATI DA TUBO "TET" LUCIDO IN AISI 304 - 316

- ART. RMM 215 - CURVE A MANDRINARE A 90°
- ART. RMM 233 - CURVE A MANDRINARE A 180°
- ART. RMM 234 - CURVE A MANDRINARE A 45°

Dimensioni Dimensions DN - DIN	D mm	S mm	A mm	B mm	R mm	E mm
25	28	1,5	70	73	43	24
32	34	1,5	80	83	52	27
40	40	1,5	90	89	60	27
50	52	1,5	100	103	72	30
65	70	2	110	108	85	30
80	85	2	130	120	93	30
100	101,6	2	150	150	110	35

Dimensioni Dimensions DN-pollici/inches	D mm	S mm	A mm	B mm	R mm	E mm
1"	25,4	1,5	75	80	25	25
1 1/2"	38,1	1,5	90	105	38	30
2"	50,8	1,5	100	103	51	30
2 1/2"	63,5	2	115	115	63	35
3"	76,2	2	130	135	76	35

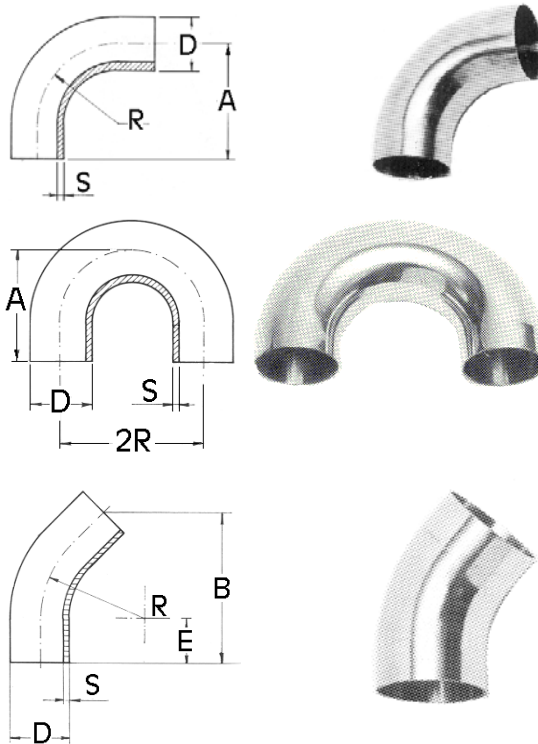

RIDUZIONI CONCENTRICHE ED ECCENTRICHE DA MANDRINARE

ESECUZIONE LUCIDA AISI 304 - 316

ART. RMM 236
RIDUZIONE CONCENTRICA

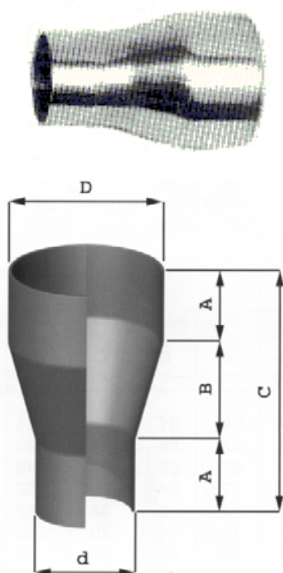

Dimensioni DIN - DN					
DIN	D/d	A	B	C	S
32 / 25	34 x 28	30	20	80	1,5
40 / 25	40 x 28	35	32	102	1,5
40 / 32	40 x 34	35	18	88	1,5
50 / 25	52 x 28	40	35	115	1,5
50 / 32	52 x 34	40	49	129	1,5
50 / 40	52 x 40	40	33	113	1,5
65 / 40	70 x 40	35	47	117	1,5
65 / 50	70 x 52	40	55	135	1,5
80 / 50	85 x 52	40	40	120	2
80 / 65	85 x 70	40	40	120	2
100 / 50	101 x 52	40	80	160	2
100 / 65	101 x 70	40	47	127	2
100 / 80	101 x 85	40	40	120	2

Dimensioni DN - Pollici					
Pollici	D/d	A	B	C	S
1 1/2" - 1"	38,1 x 25,4	40	17	97	1,5
2" - 1"	50,8 x 25,4	40	35	115	1,5
2" - 1 1/2"	50,8 x 38,1	40	17	97	1,5
2 1/2" - 1 1/2"	63,5 x 38,1	40	35	115	1,5
2 1/2" - 2"	63,5 x 50,8	40	17	97	1,5
3" - 1 1/2"	76,1 x 38,1	40	52	132	1,5
3" - 2"	76,1 x 50,8	40	50	130	1,5
3" - 2 1/2"	76,1 x 63,5	40	17	97	1,5

ART. RMM 237
RIDUZIONE ECCENTRICA

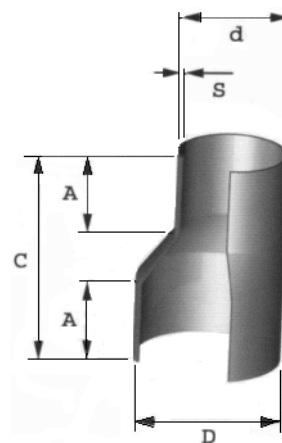

RACCORDI DA MANDRINARE
RICAVATI DA TUBO "TET" LUCIDO IN AISI 304 - 316

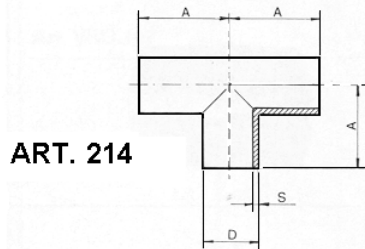

ART. 214

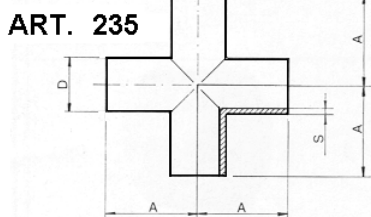

ART. 235

Dimensioni DIN	DN	D	S	A
	25	28	1,5	50
32	34	1,5	56	
40	40	1,5	67	
50	52	1,5	72	
65	70	2,00	85	
80	80-83	2,00	120	
90	88,9	2,00	120	
100	101,6	2,00	120	
Dimensioni SMS	1"	25,4	1,5	75
	1 1/2"	38,2	1,5	90
	2"	50,8	1,5	100
	2 1/2"	63,5	1,50	115
	3"	76,1	2,00	130

Pezzo a T a mandrinare per industrie alimentari

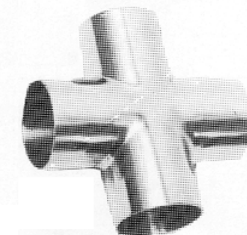
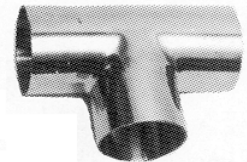

Croce a mandrinare per industrie alimentari

DN	A	B	C	D	S
32/25	56	61	28	34	1,5
40/25	67	56	28	40	1,5
40/32	67	65	34	40	1,5
50/25	72,5	64,5	28	52	1,5
50/32	72,5	82	34	52	1,5
50/40	72,5	76	40	52	1,5
65/32	85	82	34	70	2/1,5
65/40	85	85	40	70	2/1,5
65/50	85	85	52	70	2/1,5
80/40	97,5	99	40	85	2/1,5
80/50	97,5	92,5	52	85	2/1,5
80/65	97,5	92,5	70	85	2
100/50	150		52	101,6	2
100/65	150	167	70	101,6	2
100/80	150		85	101,6	2

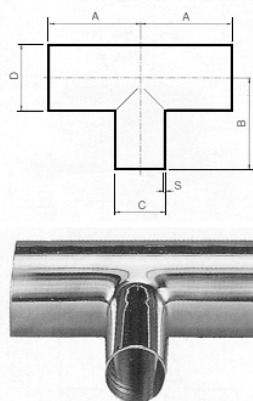

ART. 238

TEE A MANDRINARE RIDOTTO

A richiesta pezzi speciali a mandrinare misure DIN - SMS

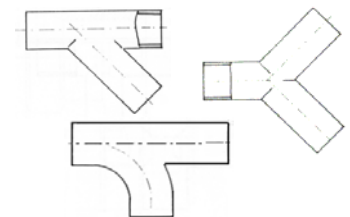

MANDRINI PER TUBI ALIMENTARI

SIGLA	TUBO	
	Øe. mm	Øi. min. mm
DIN. 25	28	26
DIN. 32	34	32
DIN. 40	40	38
DIN. 50	52	50
DIN. 60	60	57
DIN. 65	70	66
DIN. 80	85	81
DIN. 90	93	89
DIN. 100	106	101



ART. RD 218

SIGLA	TUBO	
	Øe. mm	Øi. mm
BS. 1"	25,4	22,9
BS. 1 1/2"	38,1	35,6
BS. 2"	50,8	48,3
BS. 2 1/2"	63,5	60,5
BS. 3"	76,2	73,2
BS. 3 1/2"	88,9	84,9
BS. 4"	101,6	97,6



ART. RD 301

ART. RD 303

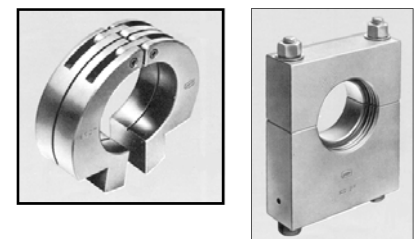

ART. RD 305